



EMILE 30" TOWEL RAIL

FEATURES

- Solid brass construction
- Easy installation mounting brackets

COLORS/FINISHES

- #CP Polished Chrome
- #BN Brushed Nickel



INSTALLATION NOTES

Please refer to the installation manual for further instructions.

WARRANTY

- Five-year Limited Warranty for residential use
- One-year Limited Warranty for commercial use

SHIPPING INFORMATION

Package Dimensions

36 5/8" x 4 5/16" x 2 3/16"

Package Weight

2.6 lbs

MATERIAL

- Brass
- Zinc

DIMENSIONS

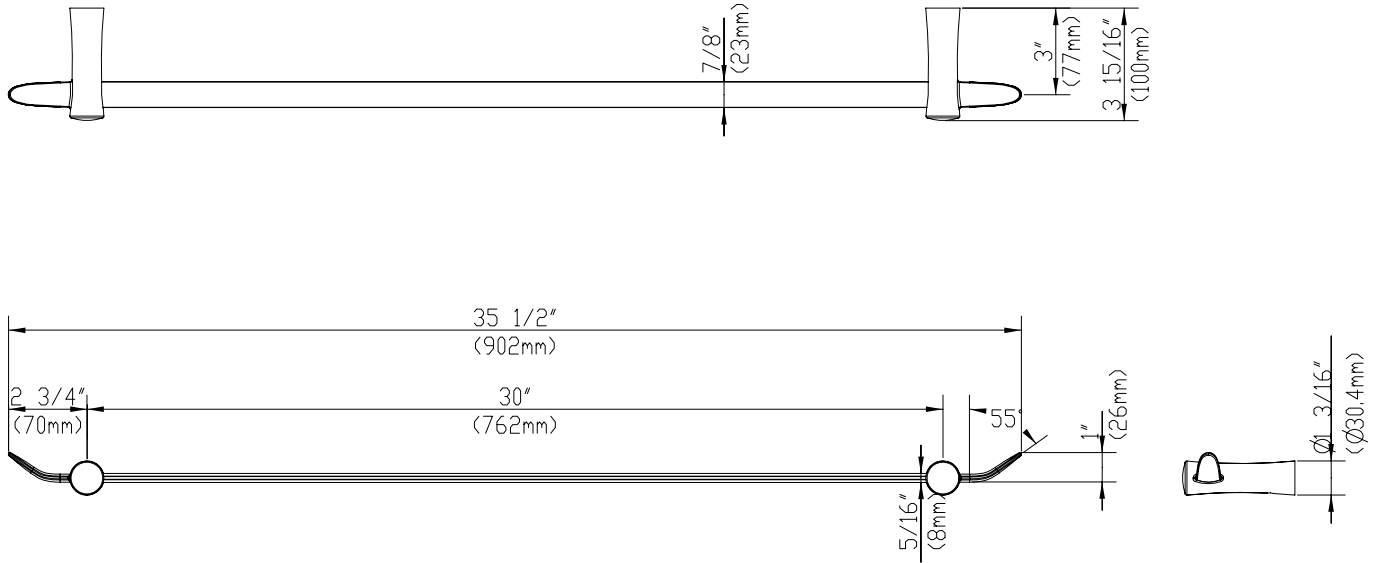

SERVICE PARTS

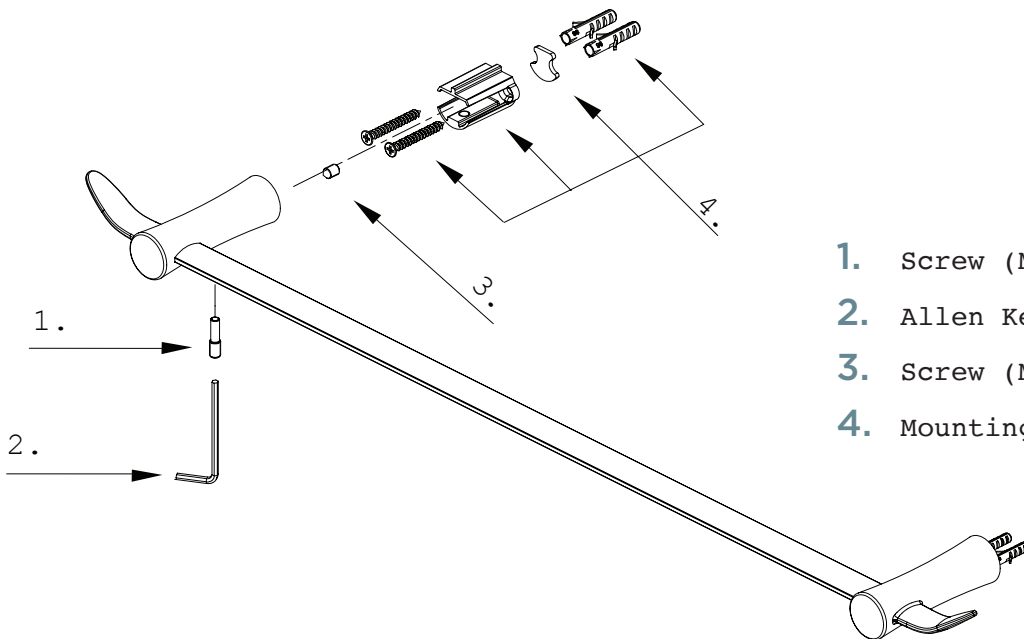

1. Screw (M5*19mm L) (RB0123)
2. Allen Key (A031000)
3. Screw (M5*8mm L) (A075208)
4. Mounting Hardware (RB0124)